

# SMPS Capacitors Chip Assemblies

## CH/CV - Radial, Dual-in-Line, 4 Terminal/SMT 'J' & 'L' Ranges

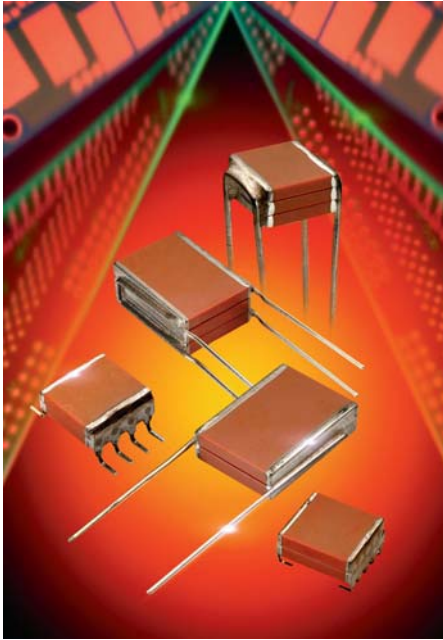

10nF to 180  $\mu$ F  
50V to 500 VDC  
-55°C to +125°C

BS9100 approved  
Low ESR/ESL  
1B/C0G and 2C1/X7R Dielectrics

This range allows SMPS engineers to select the best volumetric solution for input and output filter applications in high reliability designs. Utilizing advanced multilayer ceramic techniques to minimize ESR/ESL giving high current handling properties appropriate for filtering, smoothing and decoupling circuits.

### ELECTRICAL SPECIFICATIONS

#### Temperature Coefficient CECC 30 000, (4.24.1)

1B/C0G: A Temperature Coefficient -  $0 \pm 30$  ppm/°C, -55° to +125°C  
2C1/X7R: C Temperature Characteristic -  $\pm 15\%$ , -55° to +125°C

#### Capacitance Test 25°C

1B/C0G: Measured at 1 VRMS max at 1KHz (1MHz for 100 pF or less)  
2C1/X7R: Measured at 1 VRMS max at 1KHz

#### Dissipation Factor 25°C

1B/C0G: 0.15% max at 1KHz, 1 VRMS max (1MHz for 100 pF or less)  
2C1/X7R: 2.5% max at 1KHz, 1 VRMS max

#### Insulation Resistance 25°C

1B/C0G & 2C1/X7R: 100K megohms or 1000 megohms- $\mu$ F, whichever is less

#### Dielectric Withstanding Voltage 25°C (Flash Test)

1B/C0G & 2C1/X7R: 250% rated voltage for 5 seconds with 50 mA max charging current. (500 Volt units @ 150% rated voltage)

#### Dielectric Withstanding Voltage 25°C (Flash Test)

1B/C0G & 2C1/X7R: 250% rated voltage for 5 seconds with 50 mA max charging current. (500 Volt units @ 150% rated voltage)

#### Life Test (1000 hrs) CECC 30 000 (4.23)

1B/C0G & 2C1/X7R: 200% rated voltage at +125°C. (500 Volt units @ 120% rated voltage)

#### Damp Heat IEC 68-2-3, 56 days.

#### Thermal Shock IEC 68-2-14

-55°C to +125°C, 5 cycles

#### Resistance to Solder Heat IEC 68-2-20

#### Vibration IEC 68-2-6

10Hz - 2000Hz, 0.75mm or 98m/sec<sup>2</sup>, 6 hrs.

#### Bump IEC 68-2-29

390m/sec<sup>2</sup>, 4000 bumps

### MARKING

#### CH and CV 4x, 5x, 81-84

A5C	Top line A (AVX). Voltage code, dielectric code.
225K	Middle line capacitance code, tolerance code.
xxxxxx	Bottom line 6 digit batch code.

#### Other CH, CV Styles

AVX	Top line AVX.
5C	Second line voltage code, dielectric code.
156M	Third line capacitance code, tolerance code.
xxxxxx	Bottom line, 6 digit batch code.



# SMPS Capacitors (CV Style)



## Chip Assemblies

### VERTICALLY MOUNTED RADIAL PRODUCT

Part Number format (CVxxxxxxxxxxA2)

Typical Part Number CV525C106MA30A2

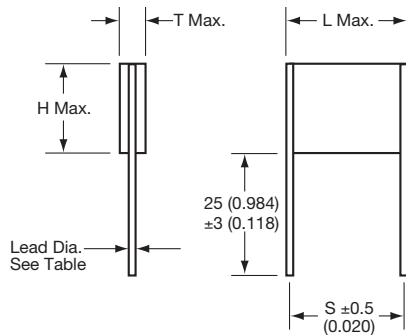

#### DIMENSIONS

millimeters (inches)

Style	L (max)	H (max)	S (nom)	Lead Dia (nom)
CV41-44	10.6 (0.417)	8.7 (0.342)	8.2 (0.322)	0.7 (0.028)
CV51-54	11.9 (0.468)	10.7 (0.421)	10.2 (0.400)	0.9 (0.035)
CV61-64	16.5 (0.649)	13.6 (0.535)	15.2 (0.600)	0.9 (0.035)
CV71-74	17.8 (0.700)	21.6 (0.850)	15.2 (0.600)	0.9 (0.035)
CV76-79	22.7 (0.893)	16.6 (0.653)	21.2* (0.834)	0.9 (0.035)

\*Tolerance ± 0.8

millimeters (inches)

Style	T max
CV41/51/61/71/76	3.80 (0.150)
CV42/52/62/72/77	7.40 (0.291)
CV43/53/63/73/78	11.1 (0.437)
CV44/54/64/74/79	14.8 (0.583)

### VERTICALLY MOUNTED 4 TERMINAL RADIAL PRODUCT

Part Number format (CVxxxxxxxx3xx4)

Typical Part Number CV435C106MA30A4

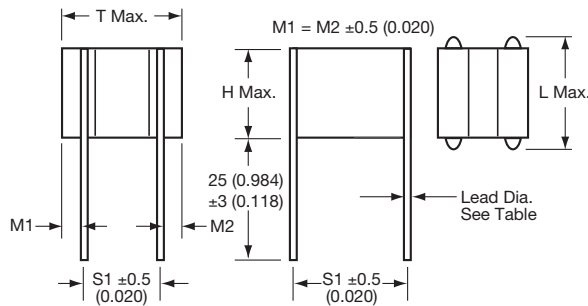

#### DIMENSIONS

millimeters (inches)

Style	L (max)	H (max)	S (nom)	Lead Dia (nom)
CV43-44	10.6 (0.417)	8.7 (0.342)	8.2 (0.322)	0.7 (0.028)
CV53-54	11.9 (0.468)	10.7 (0.421)	10.2 (0.400)	0.9 (0.035)
CV63-64	16.5 (0.649)	13.6 (0.535)	15.2 (0.600)	0.9 (0.035)
CV73-74	17.8 (0.700)	21.6 (0.850)	15.2 (0.600)	0.9 (0.035)
CV78-79	22.7 (0.893)	16.6 (0.653)	21.2* (0.834)	0.9 (0.035)

\*Tolerance ± 0.8 (0.031)

millimeters (inches)

Style	T max	S1
CV43/53/63/73/78	11.1 (0.437)	5.08 (0.200)
CV44/54/64/74/79	14.8 (0.583)	7.62 (0.300)

Note 1. This style is only available in 3 & 4 chip assemblies

### HOW TO ORDER

Style Code	Size Code	Voltage Code	Dielectric Code	Capacitance Code	Capacitance Tolerance	Specification Code	Finish Code	Lead Dia. Code	Lead Space Code	Lead Style Code
(see product section)										
CV	52	5	C	106	M	A	3	0	A	2
		5 = 50V 1 = 100V 2 = 200V 7 = 500V	A = C0G C = X7R	(2 significant digits + no. of zeros) eg. 105 = 1 μF 106 = 10 μF 107 = 100 μF	C0G: J = ±5% K = ±10% M = ±20% X7R: K = ±10% M = ±20% P = +100, -0%	A = Non-customized	3 = Uncoated 8 = Coated (classified as uninsulated)	0 = Standard	A = Standard	2 = 2 Terminal 4 = 4 Terminal See Note 1 above

Note: See page 109 for How to Order BS9100 parts



# SMPS Capacitors (CH Style)



## Chip Assemblies

### HORIZONTALLY MOUNTED 4 TERMINAL RADIAL PRODUCT

Part Number format (CHxxxxxxxx3xx4)

Typical Part Number CH782C106MA30A4

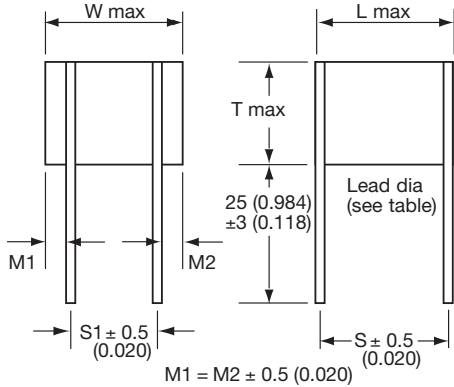

#### DIMENSIONS

millimeters (inches)

Style	L (max)	W (max)	S (nom)	S Lead Dia (nom)	S1 (nom)
CH42-44	10.6 (0.417)	8.7 (0.342)	8.2 (0.322)	0.7 (0.028)	5.08 (0.200)
CH52-54	11.9 (0.468)	10.7 (0.421)	10.2 (0.400)	0.9 (0.035)	7.62 (0.300)
CH62-64	16.5 (0.649)	13.6 (0.535)	15.2 (0.600)	0.9 (0.035)	7.62 (0.300)
CH72-74	17.8 (0.700)	21.6 (0.850)	15.2 (0.600)	0.9 (0.035)	15.2 (0.600)
CH77-79	22.7 (0.893)	16.6 (0.653)	21.2* (0.834)	0.9 (0.035)	10.2 (0.400)
CH82-84	14.1 (0.555)	38.2 (1.503)	10.2 (0.400)	0.9 (0.035)	27.9 (1.100)
CH87-89	17.8 (0.700)	38.2 (1.503)	15.2 (0.600)	1.0 (0.039)	27.9 (1.100)
CH92-94	22.7 (0.893)	40.6 (1.598)	21.2* (0.834)	1.2 (0.047)	30.5 (1.200)

\*Tolerance ± 0.8

NOTE: This style is only available in 2, 3 & 4 chip assemblies only millimeters (inches)

Style	T max
CH42/52/62/72/77/87/92	7.4 (0.291)
CH43/53/63/73/78/88/93	11.1 (0.437)
CH44/54/64/74/79/89/94	14.8 (0.583)

### HORIZONTALLY MOUNTED DUAL-IN-LINE PRODUCT

Part Number format (CHxxxxxxxx0A0)

Typical Part Number CH615C106MA30A0

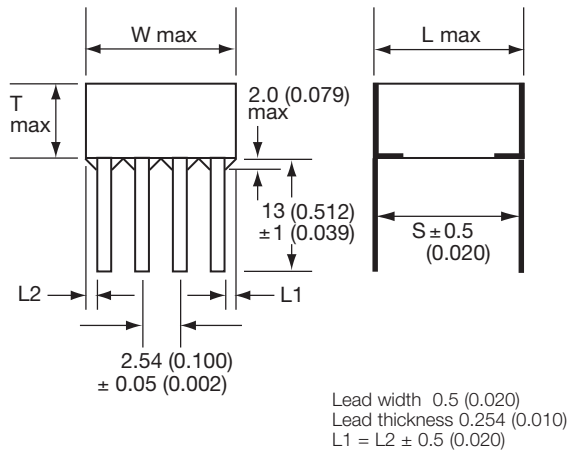

Lead width 0.5 (0.020)  
Lead thickness 0.254 (0.010)  
L1 = L2 ± 0.5 (0.020)

#### DIMENSIONS

millimeters (inches)

Style	L (max)	W (max)	S (nom)	No. of Leads per side
CH41-44	9.2 (0.362)	8.7 (0.342)	8.2 (0.322)	3
CH51-54	10.7 (0.421)	10.7 (0.421)	10.2 (0.400)	4
CH61-64	14.9 (0.586)	13.6 (0.535)	14.0 (0.551)	5
CH71-74	16.8 (0.661)	21.6 (0.850)	15.2 (0.600)	7
CH76-79	21.6 (0.850)	16.6 (0.653)	20.3* (0.800)	6
CH81-84	12.0 (0.472)	38.2 (1.503)	10.2 (0.400)	14
CH86-89	18.9 (0.744)	38.2 (1.503)	15.2 (0.600)	14
CH91-94	24.0 (0.944)	40.6 (1.598)	20.3* (0.800)	14

\*Tolerance ± 0.8 (0.031)

millimeters (inches)

Style	T max
CH41/51/61/71/76/81/86/91	3.8 (0.150)
CH42/52/62/72/77/82/87/92	7.4 (0.291)
CH43/53/63/73/78/83/88/93	11.1 (0.437)
CH44/54/64/74/79/84/89/94	14.8 (0.583)

### HOW TO ORDER

CH	52	5	C	106	M	A	3	0	A	0
<b>Style Code</b> (see product section)	<b>Size Code</b>	<b>Voltage Code</b>	<b>Dielectric Code</b>	<b>Capacitance Code</b>	<b>Capacitance Tolerance</b>	<b>Specification Code</b>	<b>Finish Code</b>	<b>Lead Dia. Code</b>	<b>Lead Space Code</b>	<b>Lead Style Code</b>
	5 = 50V 1 = 100V 2 = 200V 7 = 500V	A = COG C = X7R	(2 significant digits + no. of zeros) eg. 105 = 1 µF 106 = 10 µF 107 = 100 µF	COG: J = ±5% K = ±10% M = ±20% X7R: K = ±10% M = ±20% P = +100, -0%	A = Non-customized	3 = Uncoated 8 = Coated (classified as uninsulated)	0 = Standard	A = Standard	0 = Straight dual in line 4 = 4 Terminal	

Note: See page 109 for How to Order BS9100 parts



# SMPS Capacitors (CH Style)



## Chip Assemblies

### HORIZONTALLY MOUNTED 'L' LEAD SMT PRODUCT

Part Number format (CHxxxxxxxxxx0A7)

Typical Part Number CH411C275KA30A7

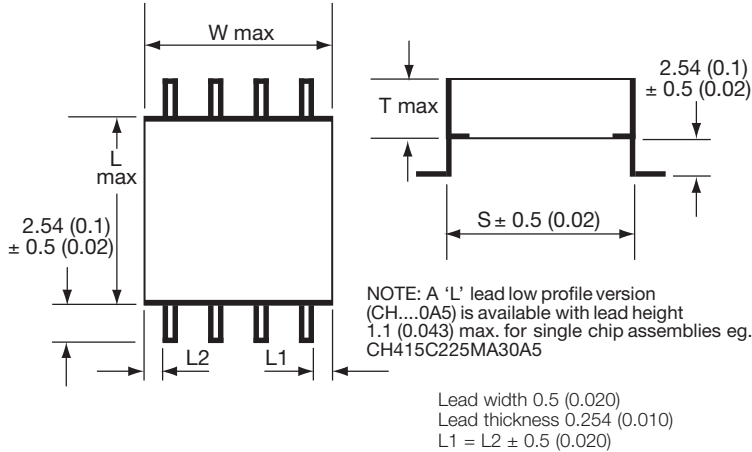

#### DIMENSIONS

millimeters (inches)

Style	L (max)	W (max)	S (nom)	No. of Leads per side
CH41-44	9.2 (0.362)	8.7 (0.342)	8.2 (0.322)	3
CH51-54	10.7 (0.421)	10.7 (0.421)	10.2 (0.400)	4
CH61-64	14.9 (0.586)	13.6 (0.535)	14.0 (0.551)	5
CH71-74	16.8 (0.661)	21.6 (0.850)	15.2 (0.600)	7
CH76-79	21.6 (0.850)	16.6 (0.653)	20.3* (0.800)	6
CH81-84	12.0 (0.472)	38.2 (1.503)	10.2 (0.400)	14
CH86-89	18.9 (0.744)	38.2 (1.503)	15.2 (0.600)	14
CH91-94	24.0 (0.944)	40.6 (1.598)	20.3* (0.800)	14

\*Tolerance ± 0.8 (0.031)

millimeters (inches)

Style	T max
CH41/51/61/71/76/81/86/91	3.8 (0.150)
CH42/52/62/72/77/82/87/92	7.4 (0.291)
CH43/53/63/73/78/83/88/93	11.1 (0.437)
CH44/54/64/74/79/84/89/94	14.8 (0.583)

### HORIZONTALLY MOUNTED 'J' LEAD SMT PRODUCT

Part Number format (CHxxxxxxxxxx0A8)

Typical Part Number CH411C275KA30A8

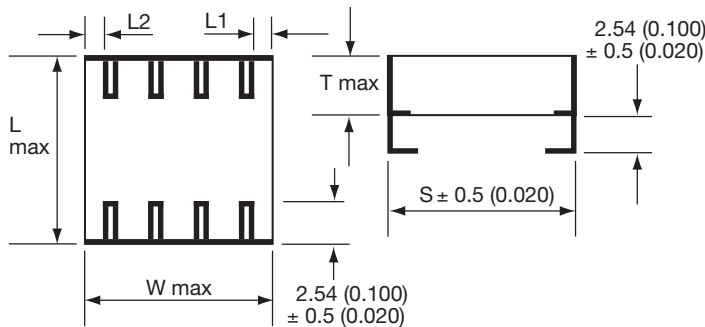

#### DIMENSIONS

millimeters (inches)

Style	L (max)	W (max)	S (nom)	No. of Leads per side
CH41-44	9.2 (0.362)	8.7 (0.342)	8.2 (0.322)	3
CH51-54	10.7 (0.421)	10.7 (0.421)	10.2 (0.400)	4
CH61-64	14.9 (0.586)	13.6 (0.535)	14.0 (0.551)	5
CH71-74	16.8 (0.661)	21.6 (0.850)	15.2 (0.600)	7
CH76-79	21.6 (0.850)	16.6 (0.653)	20.3* (0.800)	6
CH81-84	12.0 (0.472)	38.2 (1.503)	10.2 (0.400)	14
CH86-89	18.9 (0.744)	38.2 (1.503)	15.2 (0.600)	14
CH91-94	24.0 (0.944)	40.6 (1.598)	20.3* (0.800)	14

\*Tolerance ± 0.8 (0.031)

millimeters (inches)

Style	T max
CH41/51/61/71/76/81/86/91	3.8 (0.150)
CH42/52/62/72/77/82/87/92	7.4 (0.291)
CH43/53/63/73/78/83/88/93	11.1 (0.437)
CH44/54/64/74/79/84/89/94	14.8 (0.583)

### HOW TO ORDER

Style Code	Size Code	Voltage Code	Dielectric Code	Capacitance Code	Capacitance Tolerance	Specification Code	Finish Code	Lead Dia. Code	Lead Space Code	Lead Style Code
CH	52	5	C	106	M	A	3	0	A	7
(see product section)		5 = 50V 1 = 100V 2 = 200V 7 = 500V	A = COG C = X7R	(2 significant digits + no. of zeros) eg. 105 = 1 µF 106 = 10 µF 107 = 100 µF	COG: J = ±5% K = ±10% M = ±20% X7R: K = ±10% M = ±20% P = +100, -0%	A = Non-customized	3 = Uncoated 8 = Coated (classified as uninsulated)	0 = Standard	A = Standard	3 = Low profile 'J' (single chip) 5 = Low profile 'L' (single chip) 7 = 'L' Dual in line 8 = 'J' Dual in line

Note: See page 109 for How to Order BS9100 parts



# SMPS Capacitors (CH/CV Style)



## Chip Assemblies

### C0G DIELECTRIC ULTRA STABLE CERAMIC

Cap $\mu$ F	CH/CV41-44 Styles				CH/CV51-54 Styles				CH/CV61-64 Styles				CH/CV71-74 Styles				CH/CV76-79 Styles				CH81-84 Styles				CH86-89 Styles				CH91-94 Styles										
	50	100	200	500	50	100	200	500	50	100	200	500	50	100	200	500	50	100	200	500	50	100	200	500	50	100	200	500	50	100	200	500	50	100	200	500			
Voltage DC																																							
0.01				41																																			
0.012				41																																			
0.015				41																																			
0.018				41																																			
0.022				42						51																													
0.027				42						51																													
0.033			41	42						52			61																										
0.039			41	42						52			61																										
0.047		41	41	43						52			61																										
0.056		41	41	43						52			61																										
0.068	41	41	41	44						51	53			62			71			76			81																
0.082	41	41	42							51	53			62			71			76			81																
0.1	41	42	42							51	51	54			62			71			76			81															
0.12	42	42	42		51	51	52						61	62			72			77			81				86												
0.15	42	42	42		51	52	52						61	61	63			72			77			81			86												
0.18	42	42	43		51	52	52						61	61	63			72			77			82			86												
0.22	42	43	43		52	52	52						61	61	62	64			71	72			76	77			81	82			86			91					
0.27	43	43	44		52	52	53						61	62	62			71	71	73			76	76	78		81	81	82			87			91				
0.33	43	44			52	53	53						61	62	62			71	71	73			76	76	78		81	81	82			87			91				
0.39	44				52	53	54						62	62	62			71	71	72	74			76	76	77	79	81	81	81	83			86	87		92		
0.47					53	54							62	62	63			71	71	72			76	76	77		81	81	81	83			86	87		92			
0.56					53								62	63	63			71	72	72			76	77	77		81	81	82	84			86	86	88		92		
0.68					54								62	63	64			72	72	72			77	77	77		81	82	82			86	86	86	88		92		
0.82													63	64				72	72	73			77	77	78		82	82	82			86	86	87	89		91	93	
1													63	64				72	72	73			77	77	78		82	82	82			86	87	87		91	91	93	
1.2													64					72	73	74			77	78	79		82	82	83			87	87	87		91	91	92	94
1.5																		73	73				78	78			82	83	83			87	87	87		91	92	92	
1.8																		73	74				78	79			83	83	84			87	87	88		92	92	92	
2.2																		74					79				83	84			87	88	88		92	92	92		
2.7																											84				88	88	89		92	92	93		
3.3																															88	89			92	93	93		
3.9																														89				93	93	94			
4.7																																		93	94				
5.6																																		94					

NB Figures in cells refer to size within ordering information

# SMPS Capacitors (CH/CV Style)



## Chip Assemblies

### X7R DIELECTRIC STABLE CERAMIC

Cap $\mu$ F	CH/CV41-44 Styles				CH/CV51-54 Styles				CH/CV61-64 Styles				CH/CV71-74 Styles				CH/CV76-79 Styles				CH81-84 Styles				CH86-89 Styles				CH91-94 Styles												
	50	100	200	500	50	100	200	500	50	100	200	500	50	100	200	500	50	100	200	500	50	100	200	500	50	100	200	500	50	100	200	500	50	100	200	500					
Voltage DC																																									
0.12				41																																					
0.15				41																																					
0.18				41																																					
0.22				41																																					
0.27				42							51																														
0.33				41	42						51																														
0.39				41	42						51																														
0.47				41	42						52				61																										
0.56				41	43						52				61																										
0.68				42	43					51	52				61																										
0.82				42	44					51	52				61				71				76				81														
1				41	42	44				51	53				61	62				71			76				81														
1.2				41	42					52	53				61	62				71			76				81														
1.5				41	43					52	54				61	62				71			76				81									86					
1.8	41	41	43							52					61	62				72			77				82									86					
2.2	41	41	44							51	52				61	63			71	72			76	77			81	82							86						
2.7	41	41								51	53				62	63			71	72			76	77			81	82								87		91			
3.3	41	42								51	53				62	64			71	72			76	77			81	82								87		91			
3.9	42	42								51	51	54				62				72	73			77	78			81	83							86	87		91		
4.7	42	42								51	52				61	62				72	73			77	78			82	83							86	87		91		
5.6	42	42								51	52				61	63				72	74			77	79			82	84							86	88		92		
6.8	42	43								52	52				61	61	63				72			77			82									86	88		92		
8.2	43	43								52	52				61	61	64			71	73			76	78			82								87	89		91	92	
10	43	44								52	53				61	62	64			71	73			76	78			83								87		91	92		
12	44									53	53				62	62				71	71	74		76	76	79			81	83						87		92	93		
15										53	54				62	62				71	71			76	76			81	81	84						86	87		92	93	
18										54					62	63				71	72			76	77			81	81						86	88		92	94		
22										54					62	63				72	72			77	77			81	82						86	86	88		92		
27															63	64				72	72			77	77			82	82						86	86	89		93		
33															63	64				72	73			77	78			82	82						86	87		91	93		
39															64					72	73			77	78			82	82							87	87		91	91	94
47																				73	74			78	79			82	83							87	87		91	92	
56																				73				78				83	83							87	87		92	92	
68																				74				79				83	84							87	88		92	92	
82																											84									88	88		92	92	
100																																				88	89		92	93	
120																																				89			93	93	
150																																						93	94		
180																																						94			

NB Figures in cells refer to size within ordering information

